

DATA SHEET

MODEL NAME	SMD LED
PART NUMBER	A102EFCKBMP9
PACKAGE	PLCC type
COLOR	High Color Gamut White

Application
 Back light unit
 General lighting

1. Features

- (1) Each Lead can be individually controlled
 High power white color surface mount TOPLED
- (2) High flux output Flat type LED.
- (3) Compact package outline (LxW) of 5.6 x 3.0mm. Ultra low height profile – 0.85 mm.
- (4) Wide view angle : 120deg
- (5) Compatible to both IR reflow soldering and TTW soldering.
- (6) 1500unit / reel .taping
- (7) Applications : Back light unit, General light

2. Dimension

Unit : mm

General Tolerance : ± 0.10

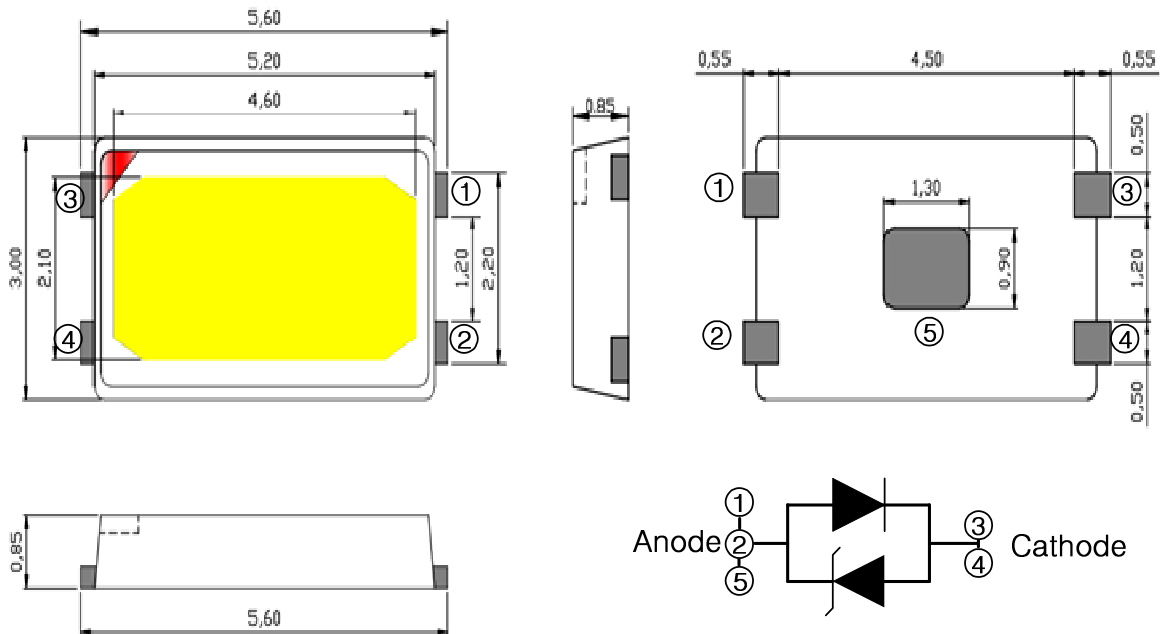

(1) Material

Item	Material
LED Chip	InGaN
ESD Protector	Chip ESD screen
Wire	Au Gold wire.
Lead-frame.	Cu Alloy With Ag Plating.
Encapsulation	Silicone
Package Polymer	PPA
Phosphor	Green(Nitride) , Red(Nitride)

3. SPECIFICATIONS

(1) Absolute Maximum Ratings.(Ta =25°C)

Parameters	Symbol	Maximum Value	Unit	Test condition
		White		
DC forward current	IF	200	mA	
Pulse current; (tp ≤ 10 ms, Duty cycle = 1/10)	IFP	350	mA	
Power dissipation (at room temperature)	PDL	700	mW	
Reverse voltage.	VZ	0.7	V	
Operating temperature.	T _{OPR}	-40 ~ +100	°C	
Storage temperature.	T _{STG}	-40 ~ +100	°C	
Soldering Temperature	T _{SOL}	Reflow Soldering :260°C /10s Hand Soldering : 350°C /3s	°C	
Chip junction temperature.	T _J	125	°C	
Thermal Resistance	R _{th}	28±5	°C/W	
Peak Wavelength	Wp	448±3	nm	

* T_J = 70 °C : 50,000hr Lifetime guarantee(@ If : 140mA)

* I_R Guarantee at Chip level

* Wp(Peak Wavelength) at Module base(BLU)

(2) Optical Characteristics at Ta=25°C.

Item	Symbol	Rank	Min.	Typ.	Max.	Condition	Unit
Luminous Intensity	IV	A	11.1		11.5	IF=120 mA	cd
		B	11.5		11.9	IF=120 mA	
		C	11.9		12.3	IF=120 mA	
		D	12.3		12.7	IF=120 mA	
		E	12.7		13.1	IF=120 mA	
		F	13.1		13.5	IF=120 mA	
Color Coordinate	CIE	ALL	Follow Detail rank			IF=120 mA	xy
Forward Voltage	VF	1	2.90		3.05	IF=120 mA	V
		2	3.05		3.20	IF=120 mA	
		3	3.20		3.35	IF=120 mA	
		4	3.35		3.50	IF=120 mA	
		5	3.50		3.65	IF=120 mA	
		6	3.65		3.80	IF=120 mA	

Luminous intensity is measured by **CAS-140** of Instrument System Co.

1. Luminous intensity is measured with an accuracy of +0~07%.
2. Forward voltage, Vf is measured with an accuracy of ± 0.05 V

4. Optical and electrical characteristics @ 25°C

Forward current vs. forward voltage.

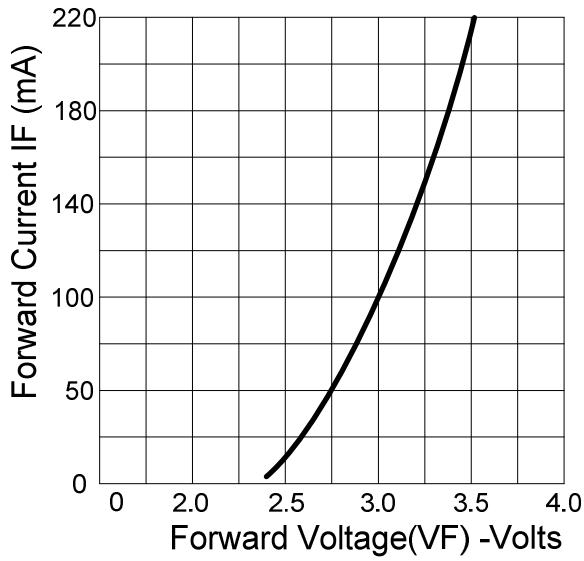

Ambient temperature vs. Forward Voltage

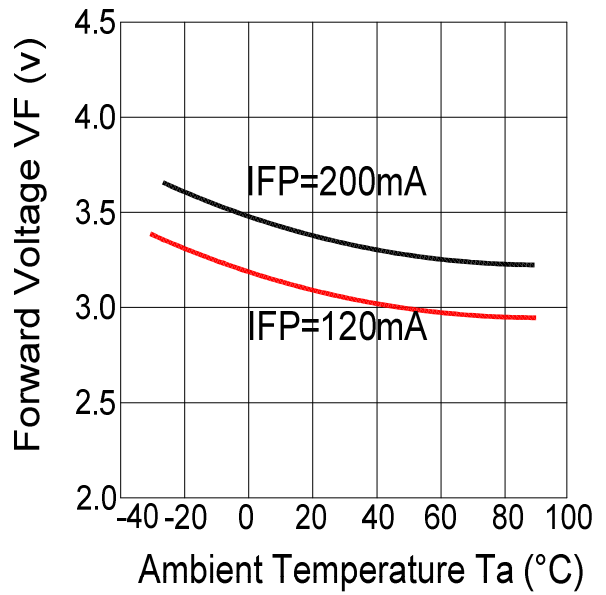

Relative luminous intensity vs. forward current.

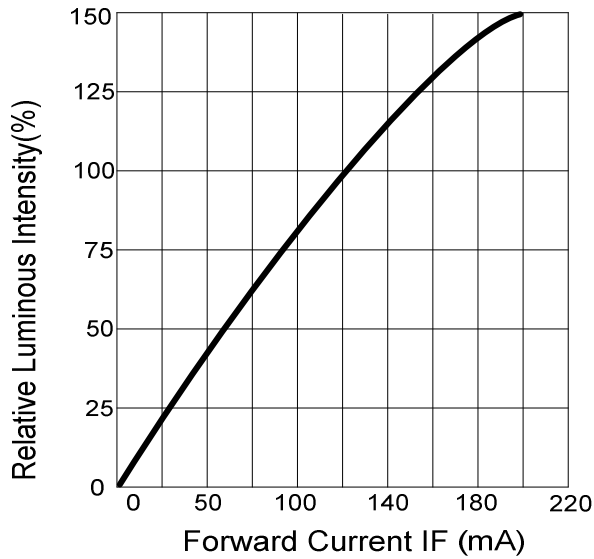

Relative Forward current vs Ambient temperature

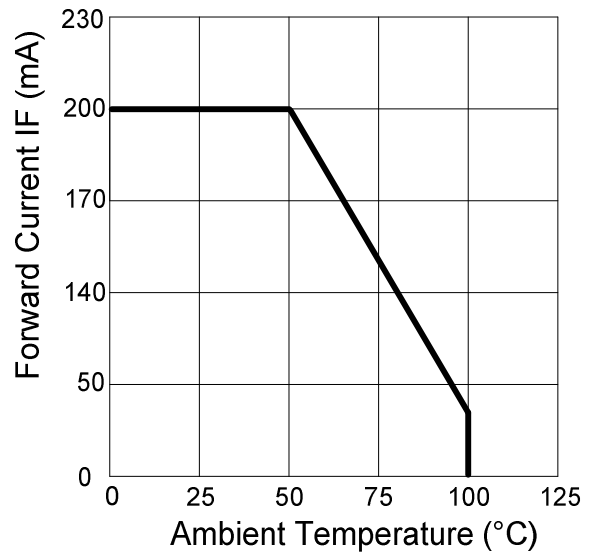

Forward Current vs. Chromaticity diagram

Spectrum

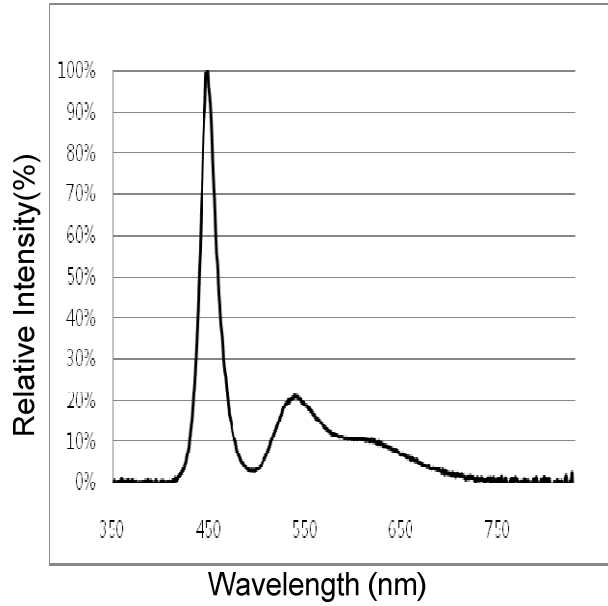
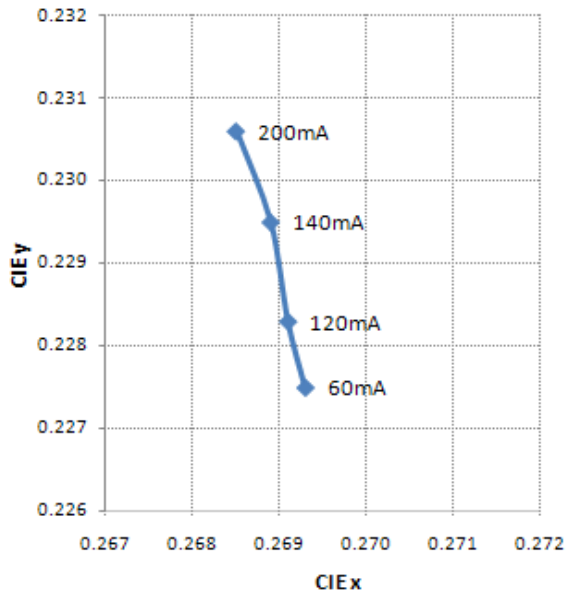

Ambient Temp. vs Chromaticity diagram

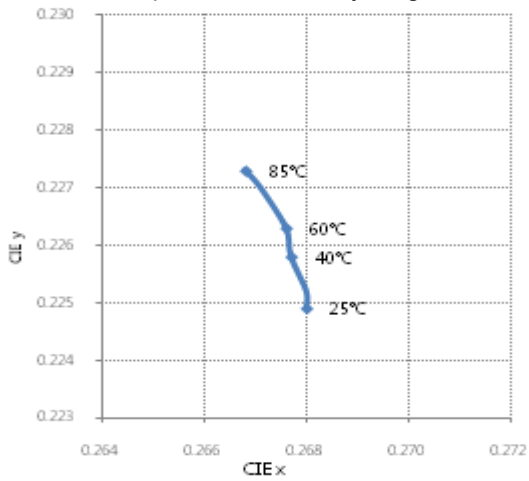

Radiation Characteristic @25°C (120mA)

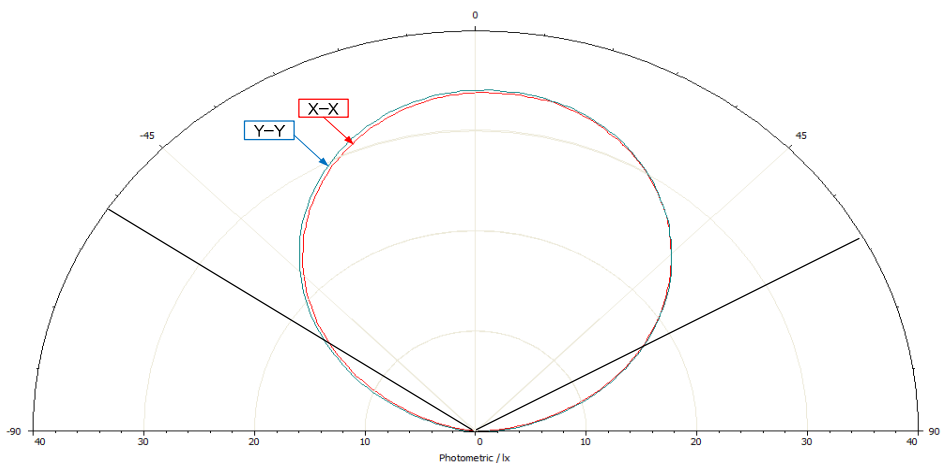

5. Material

Item	Material
1. Lead-frame. / Soldering Leads	Cu Alloy With Ni, Ag Plating.
2. Package.	High Temperature Resistant Plastic, PPA.
3. Encapsulation	Silicone Resin
4. Die	InGaN based
5. Bonding wire	Au Chip : Ball Bonding / Lead-frame Ball Bonding

Note: Product is lead-free (Pb free).

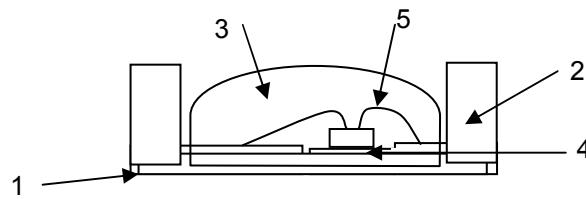

Materials and Characteristics

Carrier Tape			Cover Tape		
Description	Typical Value	Unit	Description	Typical Value	Unit
Material	Polycarbonate		Thickness	0.061+-0.013	mm
Tensile Strength(yield)	63	Mpa	Tensile Strength(break)	70	Mpa
Impact strength(notched)	10.2	Kg-cm/cm	Elongation(length)	150	%
Elongation	105	%	Elongation(lateral)	145	%
Shrinkage	<1.0	%	Tear Strength(length)	0.20	N
Surface resistivity	10E4-10E6	Ohm/sq	Tear Strength(lateral)	0.19	N
Volume resistivity	<10E6	Ohm-cm	Surface resistivity (surface)	<2.0E+09	Ohm/sq
			Surface resistivity (sealing)	<2.0E+09	Ohm/sq

7. Packaging Specification

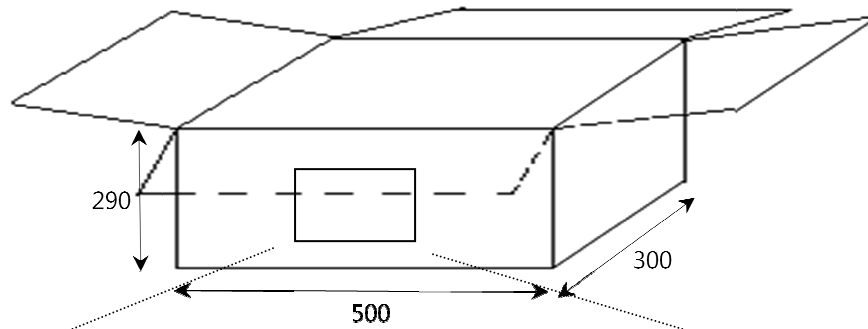
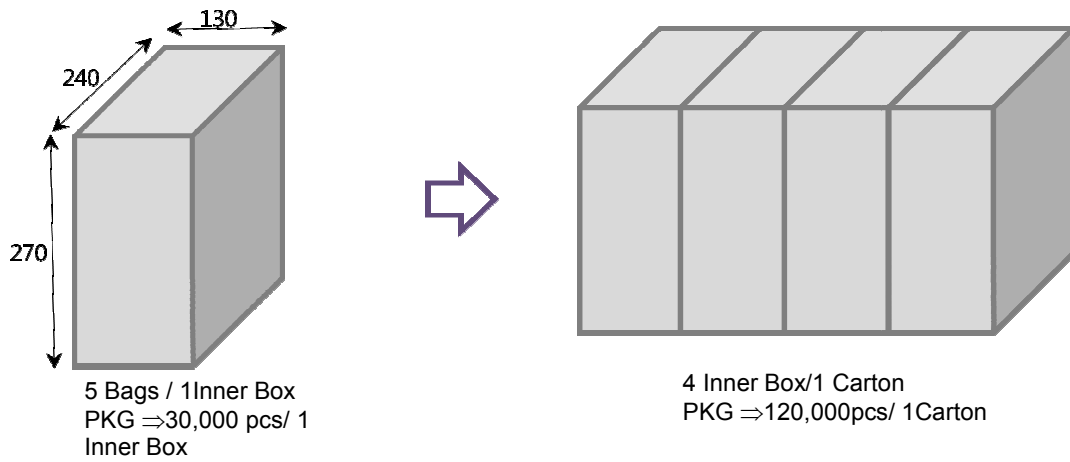
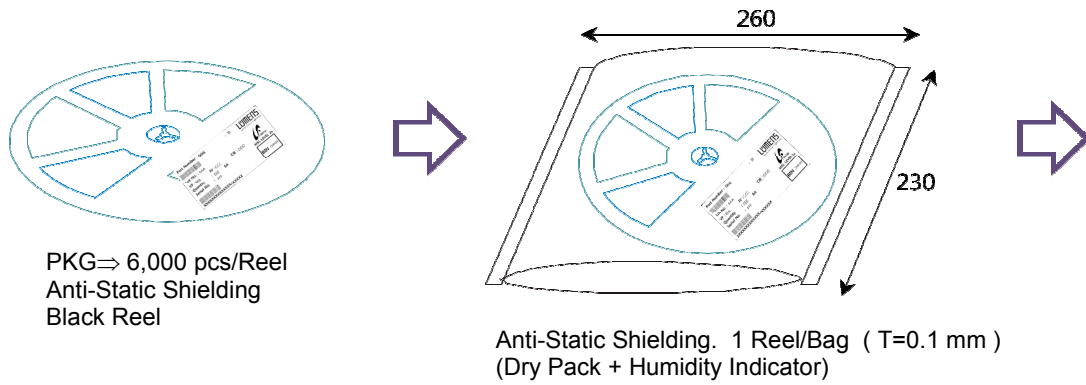

LUMENS	#456, Gonae-Dong, Gilhueng-Gu Yongin-Si, Gyeonggi-Do, 449-901, Korea / Tel : +82-31-218-1473
Customer	
Part No	
Quantity	
Date	
Carton No	

8. Reliability Test

(1) The Reliability Criteria of SMD LED

Reliability Test Matrix.

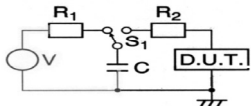
Test Item	Standard Test Method (option)	Test Conditions	Test time	Number of Damaged
Resistance to Soldering Heat (Reflow Soldering)	JEITA ED-4701 300 301	Tsld=260°C, 10sec (Pre treatment 30°C, 70%, 168hrs.)	2 times	0/50
Solderability(Reflow Soldering)	JEITA ED-4701 300 303	Tsld=215±5°C, 3sec. (Lead Solder)	1 time over 95%	0/50
Temperature Cycle	JEITA ED-4701 100 105	(-) 44°C~25°C~125°C~25°C 30min. 5min. 30min. 5min.	100cycles	0/50
High Temperature Storage	JEITA ED-4701 200 201	Ta=100°C	1000hrs.	0/50
Steady State Operating Life condition 1		Ta=25°C, IF=120mA	1000hrs.	0/50
Steady State Operating Life of High Humidity Heat		60°C, RH=90%, , IF=120mA	1000hrs	0/50
High Temperature Operating Life condition 1		85°C, IF=120mA	1000hrs	0/50
High Temperature Operating Life condition 2		70°C, IF=120mA	1000hrs	0/50
Vibration	JEITA ED-4701 400 403	100~2000~100Hz Sweep 4min. 200m/s 23direction, 4cycles	48min	0/50
ESD(HBM)		 $R_1: 10\text{ M}\Omega$, $R_2: 1.5\text{ k}\Omega$, $C: 10\text{ pF}$, $\pm 5\text{ kV}$	5 time	0/50
Pressure Cooker	JESD22-A102B	Ta=- 121°C, RH = 100% Pressure = 2atm	1time , 4hrs	0/50

Conclusions:

The reliability tests were designed to evaluate both package integrity as well as workability of product performance over time.

All samples have done well by completed test requirement and passed all the qualification criteria with zero failure. From design standpoint, the package is robust enough to meet its datasheet conditions.

Based on the good result shows on the above test, this product is qualified and released for market. All qualification samples passed.

9. Matters That Require Attention

(1) Safety Reminder

Do not look squarely at the product turned on.
(Light of the product would make your eyes hurt.)

(2) Static Electricity-handle with care

As the product is sensitive to static electricity, scrupulous attention is required in handling. Especially, if overvoltage is implied to the product, such as overvoltage higher than maximum forward voltage, the product will be damaged by energy due to the overvoltage. Do not touch terminals of the product directly with bare hands.

Also, complete measures against static electricity and/or surge should be established.

Furthermore, in order to keep down a surge current generated by ON-OFF operation below maximum rated value, it is recommended to insert an appropriate protection circuit to driver circuit.

With respect to measures against static electricity and/or surge during handling, there exist several effective measures or equipments such as human body ground connection (through 1M Ω), conductive mat, conductive working clothes, conductive shoes, anti-ESD gloves, and conductive container.

In certain circumstances or facilities in which static electricity is likely to occur, using ionizer is strongly recommended.

In case the product becomes defective by static electricity, confirm certainty of the measures.

(3) Drive Condition

The product should be driven by forward current. If reverse voltage drove the product, it would be damaged by electromigration, and thus, special cautions are needed.

(4) Handling of Silicone Resin LED Products

As the product comprises silicone encapsulation material, there is a high probability that the properties and the reliability of the product are negatively influenced by an external force, circumstances, and etc. Before using the product, please be informed of below precautions:

- The encapsulated material of the product is silicone resin, which is low strength material compared to epoxy resin. Therefore, the product requires special care in handling and precautions should be taken in designing other manufactures comprised of the product to avoid the strong pressure or stress on the encapsulated part. For instance, in case of employing surface mounter, it is required to use an adhesion nozzle which does not imply stress to the encapsulation material.
- Compared with epoxy encapsulation material, the silicone encapsulation material is prone to be stained with dust, which is deleterious to the optical characteristics of the product. Before using the product, therefore, it is required to check several circumstances including storage, handling, implement process, and usage circumstances.

(5) Soldering

In case of soldering LED product, interface detachment can take place depending on moisture absorption status of the resin. It is well-known that vaporization expansion of the absorbed moisture due to sudden heat change causes this detachment. By this detachment, the optical characteristics of the product are changed, or the reliability of the product can be declined, and thus, special cautions are required.

- Do not imply a stress to the resin at high temperature.
- In mounting the product on board (substrate) or transporting the product, it must not be contacted with other components.
- In reflow soldering, it is required that reflow process should be taken within the scope of below "Suggested Reflow Temperature Profile."
- In case reflow soldering is executed twice, the reflow soldering process should be taken at 30°C/70% RH within 168 hours.
- Flow soldering should be prohibited.
- When modification by hand soldering is needed, use a hot plate whose temperature is set below 150°C. Also, after putting mount board on the hot plate, execute hand soldering with a soldering iron (25W, below 350°C) within 3 seconds.

Recommended Pb Free IR-Reflow Soldering Profile.

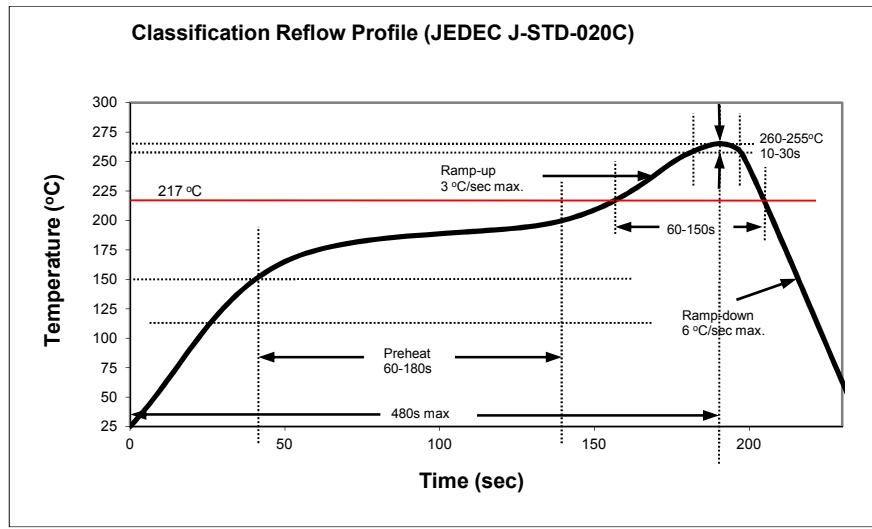

(6) Dampproof Packaging

In order to prevent moisture absorption of the resin, the product is packaged by aluminum pack including silica gel. After unsealing the pack, please use the product under below conditions:

1. In case the pack is still sealed, it is required to keep the product at 5~30°C room temperature and below 90% relative humidity, and to use the product within twelve months.
2. After unsealing the pack, it is required to implement the product at 5~30°C room temperature and below 60% relative humidity within 168 hours.
3. After unsealing the pack, in case 168 hours elapsed in above circumstances, or the term of validity has already expired, bake the product 24~48 hours at 60±5°C before usage. After baking, use the product within 72 hours.
The term of validity: twelve months from the seal date (recited in NOTE of aluminum pack label)
4. If baking process were repeated several times, there would be a possibility that detachment resistance of taping becomes weak and some disturbances can take place during mounting process. In case baking process is repeated, therefore, preventive measures are required for avoiding product destruction by static electricity.
5. Do not throw or bump down the product. If laminate packing material tore, the airtightness of the product would get damaged.
6. Indicator in the dampproof packaging functions as a hygrometer. Be advised that this indicator does not represent moisture absorption of resin.

(7) Ambient

If the product were exposed to ambient including corrosiveness gas and etc, this ambient can be a bad influence on the properties of the product.

The product is not designated to be used in special circumstances. So, prior to usage, reliability test should be taken in advance, provided that the product is used under below conditions:

- Condensation (moisture), chloride water, corrosive gas(the gas including sulfur such as SO_x, H₂S, the gas including chlorine, NO_x, NH₃, and etc.), and etc.
- Organic solvent, oil, acidic/alkaline potion, and etc.
- Outdoor use, dust, and etc.

(8) Cleaning

In case cleaning is required after board (substrate) mounting, isopropyl alcohol must be used for cleaning. However, there is a possibility that the encapsulated resin swells according to cleaning condition, and thus, checking the condition of the product is recommended before usage. Meanwhile, since a hydrochloric solvent cause corrosion of a terminal, dissolution of the resin, and/or deterioration of the product, using the hydrochloric solvent should be avoided.

- In ultrasonic waves cleaning, prior to cleaning, make sure that the product doesn't have any problem to be cleaned.
- As brushing sometimes damage a light emitting surface, it should be prohibited.

10. Standard Solder Pad

Note: Individual high power LED must not be turned on unless soldered on PCB in order to ensure proper heat dissipation.

Unit : mm

General Tolerance : ± 0.1

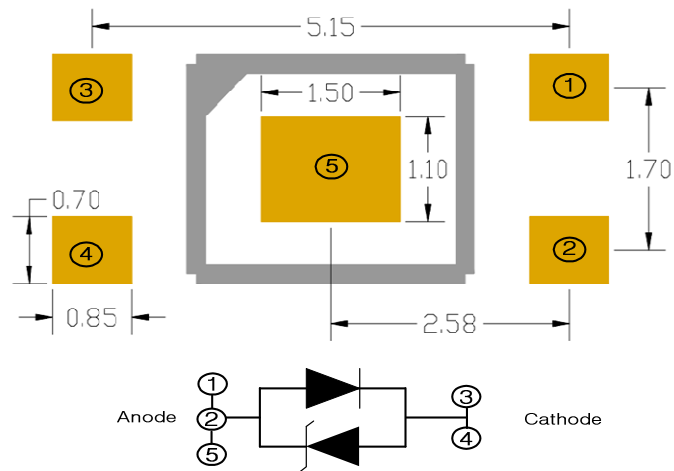

Shown is recommended pad geometry only. Customer PCB design shall include adequate thermal heat sink design & thermal analysis.