

SPECIFICATION FOR White LED Light Engine

CLEG-57D-C30WXXX

- where CL is CL(Converterless power); EG(Egg Drop); 57(length in mm); D(Downlight); F(230V); 27(Watt); W(white); X(CRI); XX(CCT)
- CLEG-57D-C30WXXX
- High brightness with long lifetime
- High power factor
- Low THD
- RoHS compliant

Vendor		Customer
Written	Approval	Approval

Lumens CO., LTD.

456 Gomae-Dong, Giheung-Gu, Yongin-Si, Gyeonggi-Do 449-901 Korea

<http://www.lumens.co.kr>

1. Product description

* Description

- The CL series module is designed for the high power operation to get the high flux output applications.
- It incorporates the state of the art SMD LEDs with high reliability and semiconductor AC direct drive ICs.
- It is ideal for the indoor or down light applications.

* Features

- High performance, High brightness over 50,000 hours of life
- No emission of harmful short wavelength light(No UV radiation)
- High power conversion efficiency(>0.85)
- High power factor (0.99)
- Low THD
- Low EMI
- Thermal shutdown function embedded(150C)
- RoHS compliant

* Applications

- Down Light (Indoor Lighting)

2. Absolute maximum ratings

Parameters	Symbol	Min Value	Max Value	Unit
Maximum power dissipation	Pd	-	33	W
Maximum operation voltage	Vop	-	130	V
Operation temperature	Top	-40	+125	°C
Storage temperature	Tst	-40	+125	°C

3. Electro-optical characteristics (Ta=25°C.)

Parameters	Symbol	Min.	Typ.	Max.	Unit	Condition
Luminous Flux	Φ_v	2230	2480	2730	lm	Vop=120V 3000K
Efficiency	lm/W		90		lm/W	Vop=120V 3000K
Correlated Color Temperature	CCT	3000 (MacAdam 3Step)			K	Vop=120V
Color Rendering Index	CRI	80	-	-	-	Vop=120V
Viewing Angle FWHM	2 θ 1/2	120	130	140	deg	Vop=120V
Operation Voltage	Vop	110	120	130	V	
Power Dissipation	Pd	27	30	33	W	Vop
Operation Frequency	Fop	50 / 60			Hz	Vop=120V
Power Factor	PF	Over 0.95			V	Vop=120V
Current THD	ATHD	Less than 20%				Vop=120V

(1) At 120Vac, Ta = 25°C

(2) Φ_v is the total luminous flux output measured with an integrated sphere.

- Measurement accuracy : CRI(±3), Φ_v (±10%), Vf(±3.0V)

(3) Correlated Color Temperature is derived from the CIE 1931 Chromaticity diagram.

4. CIE Chromaticity diagram

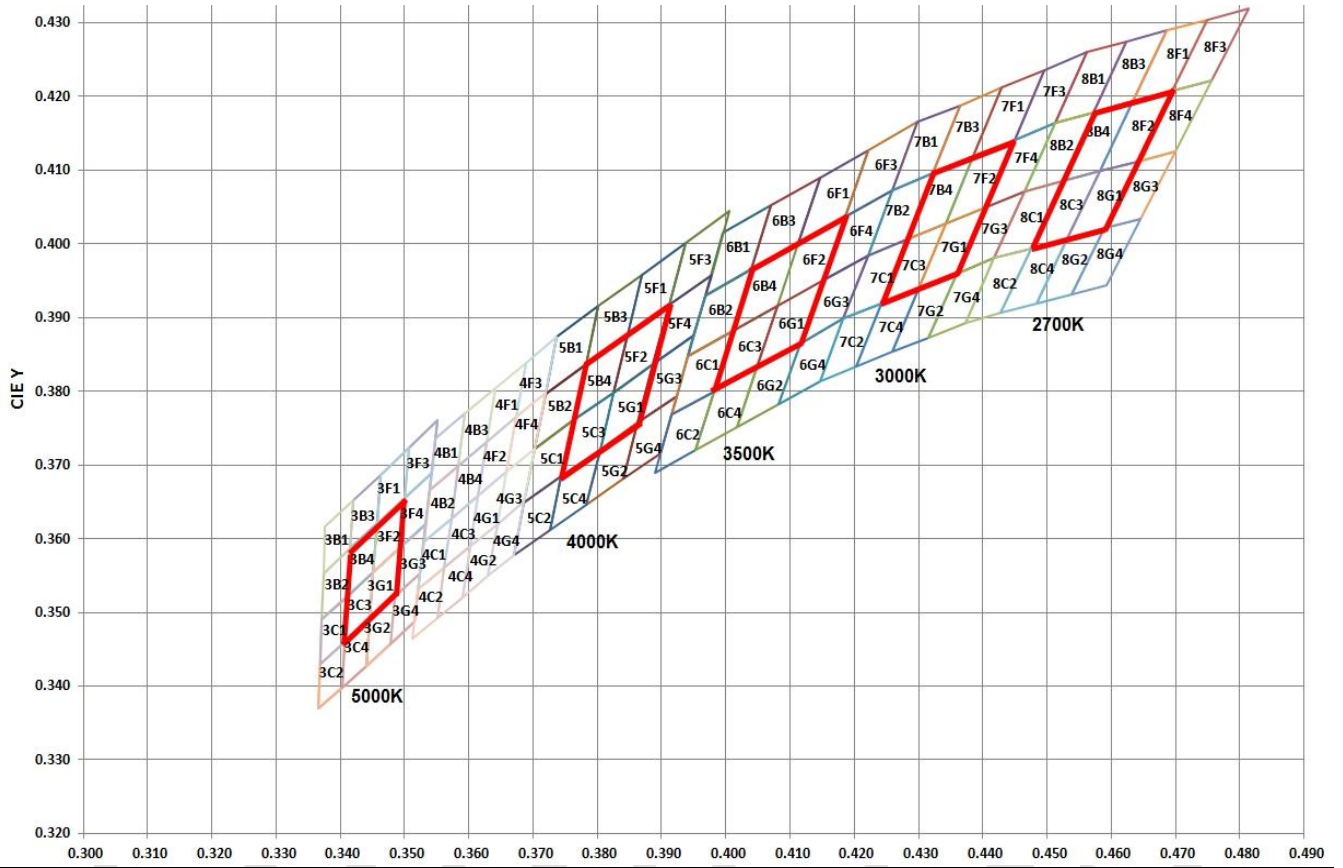

(1) Chromaticity coordinate groups are measured with an accuracy of ± 0.01

5. Chromaticity coordinates

5-1. 2700K

Region	x	y	Region	x	y	Region	x	y	Region	x	y
8B1	0.4513	0.4164	8B2	0.4465	0.4071	8B3	0.4573	0.4178	8B4	0.4523	0.4085
	0.4562	0.4260		0.4513	0.4164		0.4624	0.4274		0.4573	0.4178
	0.4624	0.4274		0.4573	0.4178		0.4687	0.4289		0.4634	0.4193
	0.4573	0.4178		0.4523	0.4085		0.4634	0.4193		0.4582	0.4099
	0.4513	0.4164		0.4465	0.4071		0.4573	0.4178		0.4523	0.4085
8C1	0.4418	0.3981	8C2	0.4373	0.3893	8C3	0.4475	0.3994	8C4	0.4428	0.3906
	0.4465	0.4071		0.4418	0.3981		0.4523	0.4085		0.4475	0.3994
	0.4523	0.4085		0.4475	0.3994		0.4582	0.4099		0.4532	0.4008
	0.4475	0.3994		0.4428	0.3906		0.4532	0.4008		0.4483	0.3919
	0.4418	0.3981		0.4373	0.3893		0.4475	0.3994		0.4428	0.3906
8F1	0.4634	0.4193	8F2	0.4582	0.4099	8F3	0.4695	0.4207	8F4	0.4641	0.4112
	0.4687	0.4289		0.4634	0.4193		0.4750	0.4304		0.4695	0.4207
	0.4750	0.4304		0.4695	0.4207		0.4813	0.4319		0.4756	0.4221
	0.4695	0.4207		0.4641	0.4112		0.4756	0.4221		0.4700	0.4126
	0.4634	0.4193		0.4582	0.4099		0.4695	0.4207		0.4641	0.4112
8G1	0.4532	0.4008	8G2	0.4483	0.3919	8G3	0.4589	0.4021	8G4	0.4538	0.3931
	0.4582	0.4099		0.4532	0.4008		0.4641	0.4112		0.4589	0.4021
	0.4641	0.4112		0.4589	0.4021		0.4700	0.4126		0.4646	0.4034
	0.4589	0.4021		0.4538	0.3931		0.4646	0.4034		0.4593	0.3944
	0.4532	0.4008		0.4483	0.3919		0.4589	0.4021		0.4538	0.3931

5-2. 3000K

Region	x	y	Region	x	y	Region	x	y	Region	x	y
7B1	0.4259	0.4073	7B2	0.4221	0.3984	7B3	0.4322	0.4096	7B4	0.42810	0.40060
	0.4299	0.4165		0.4259	0.4073		0.4364	0.4188		0.43220	0.40960
	0.4364	0.4188		0.4322	0.4096		0.4430	0.4212		0.43850	0.41190
	0.4322	0.4096		0.4281	0.4006		0.4385	0.4119		0.43420	0.40280
	0.4259	0.4073		0.4221	0.3984		0.4322	0.4096		0.42810	0.40060
7C1	0.4183	0.3898	7C2	0.4147	0.3814	7C3	0.4242	0.3919	7C4	0.42030	0.38330
	0.4221	0.3984		0.4183	0.3898		0.4281	0.4006		0.42420	0.39190
	0.4281	0.4006		0.4242	0.3919		0.4342	0.4028		0.43000	0.39390
	0.4242	0.3919		0.4203	0.3833		0.4300	0.3939		0.42590	0.38530
	0.4183	0.3898		0.4147	0.3814		0.4242	0.3919		0.42030	0.38330
7F1	0.4385	0.4119	7F2	0.4342	0.4028	7F3	0.4449	0.4141	7F4	0.44030	0.40490
	0.4430	0.4212		0.4385	0.4119		0.4496	0.4236		0.44490	0.41410
	0.4496	0.4236		0.4449	0.4141		0.4562	0.4260		0.45130	0.41640
	0.4449	0.4141		0.4403	0.4049		0.4513	0.4164		0.44650	0.40710
	0.4385	0.4119		0.4342	0.4028		0.4449	0.4141		0.44030	0.40490
7G1	0.4300	0.3939	7G2	0.4259	0.3853	7G3	0.4359	0.3960	7G4	0.43160	0.38730
	0.4342	0.4028		0.4300	0.3939		0.4403	0.4049		0.43590	0.39600
	0.4403	0.4049		0.4359	0.3960		0.4465	0.4071		0.44180	0.39810
	0.4359	0.3960		0.4316	0.3873		0.4418	0.3981		0.43730	0.38930
	0.4300	0.3939		0.4259	0.3853		0.4359	0.3960		0.43160	0.38730

5-3. 3500K

Region	x	y	Region	x	y	Region	x	y	Region	x	y
6B1	0.3968	0.3930	6B2	0.3941	0.3848	6B3	0.4040	0.3966	6B4	0.40100	0.38820
	0.3996	0.4015		0.3968	0.3930		0.4071	0.4052		0.40400	0.39660
	0.4071	0.4052		0.4040	0.3966		0.4146	0.4089		0.41130	0.40010
	0.4040	0.3966		0.4010	0.3882		0.4113	0.4001		0.40800	0.39160
	0.3968	0.3930		0.3941	0.3848		0.4040	0.3966		0.40100	0.38820
6C1	0.3915	0.3768	6C2	0.3889	0.3690	6C3	0.3981	0.3800	6C4	0.39810	0.38000
	0.3941	0.3848		0.3915	0.3768		0.4010	0.3882		0.39530	0.37200
	0.4010	0.3882		0.3981	0.3800		0.4080	0.3916		0.40170	0.37510
	0.3981	0.3800		0.3953	0.3720		0.4048	0.3832		0.40480	0.38320
	0.3915	0.3768		0.3889	0.3690		0.3981	0.3800		0.39810	0.38000
6F1	0.4113	0.4001	6F2	0.4080	0.3916	6F3	0.4186	0.4037	6F4	0.41500	0.39500
	0.4146	0.4089		0.4113	0.4001		0.4222	0.4127		0.41860	0.40370
	0.4222	0.4127		0.4186	0.4037		0.4299	0.4165		0.42590	0.40730
	0.4186	0.4037		0.4150	0.3950		0.4259	0.4073		0.42210	0.39840
	0.4113	0.4001		0.4080	0.3916		0.4186	0.4037		0.41500	0.39500
6G1	0.4048	0.3832	6G2	0.4017	0.3751	6G3	0.4116	0.3865	6G4	0.40820	0.37820
	0.4080	0.3916		0.4048	0.3832		0.4150	0.3950		0.41160	0.38650
	0.4150	0.3950		0.4116	0.3865		0.4221	0.3984		0.41830	0.38980
	0.4116	0.3865		0.4082	0.3782		0.4183	0.3898		0.41470	0.38140
	0.4048	0.3832		0.4017	0.3751		0.4116	0.3865		0.40820	0.37820

5-4. 4000K

Region	x	y	Region	x	y	Region	x	y	Region	x	y
5B1	0.3719	0.3797	5B2	0.3702	0.3722	5B3	0.3782	0.3837	5B4	0.37630	0.37600
	0.3736	0.3874		0.3719	0.3797		0.3802	0.3916		0.37820	0.38370
	0.3802	0.3916		0.3782	0.3837		0.3869	0.3958		0.38470	0.38770
	0.3782	0.3837		0.3763	0.3760		0.3847	0.3877		0.38250	0.37980
	0.3719	0.3797		0.3702	0.3722		0.3782	0.3837		0.37630	0.37600
5C1	0.3686	0.3649	5C2	0.3670	0.3578	5C3	0.3744	0.3685	5C4	0.37260	0.36120
	0.3702	0.3722		0.3686	0.3649		0.3763	0.3760		0.37440	0.36850
	0.3763	0.3760		0.3744	0.3685		0.3825	0.3798		0.38040	0.37210
	0.3744	0.3685		0.3726	0.3612		0.3804	0.3721		0.37830	0.36460
	0.3686	0.3649		0.3670	0.3578		0.3744	0.3685		0.37260	0.36120
5F1	0.3847	0.3877	5F2	0.3825	0.3798	5F3	0.3912	0.3917	5F4	0.38870	0.38360
	0.3869	0.3958		0.3847	0.3877		0.3937	0.4001		0.39120	0.39170
	0.3937	0.4001		0.3912	0.3917		0.4006	0.4044		0.39780	0.39580
	0.3912	0.3917		0.3887	0.3836		0.3978	0.3958		0.39500	0.38750
	0.3847	0.3877		0.3825	0.3798		0.3912	0.3917		0.38870	0.38360
5G1	0.3804	0.3721	5G2	0.3783	0.3646	5G3	0.3863	0.3758	5G4	0.38400	0.36810
	0.3825	0.3798		0.3804	0.3721		0.3887	0.3836		0.38630	0.37580
	0.3887	0.3836		0.3863	0.3758		0.3950	0.3875		0.39240	0.37940
	0.3863	0.3758		0.3840	0.3681		0.3924	0.3794		0.38980	0.37160
	0.3804	0.3721		0.3783	0.3646		0.3863	0.3758		0.38400	0.36810

5-5. 5000K

Region	x	y	Region	x	y	Region	x	y	Region	x	y
3B1	0.3374	0.3553	3B2	0.3371	0.3490	3B3	0.3415	0.3587	3B4	0.34110	0.35220
	0.3376	0.3616		0.3374	0.3553		0.3420	0.3652		0.34153	0.35868
	0.3420	0.3652		0.3415	0.3587		0.3463	0.3687		0.34570	0.36205
	0.3415	0.3587		0.3411	0.3522		0.3457	0.3621		0.34510	0.35540
	0.3374	0.3553		0.3371	0.3490		0.3415	0.3587		0.34110	0.35220
3C1	0.3369	0.3430	3C2	0.3366	0.3369	3C3	0.3407	0.3460	3C4	0.34030	0.33980
	0.3371	0.3490		0.3369	0.3430		0.3411	0.3522		0.34070	0.34600
	0.3411	0.3522		0.3407	0.3460		0.3451	0.3554		0.34455	0.34905
	0.3407	0.3460		0.3403	0.3398		0.3446	0.3491		0.34400	0.34270
	0.3369	0.3430		0.3366	0.3369		0.3407	0.3460		0.34030	0.33980
3F1	0.3457	0.3621	3F2	0.3451	0.3554	3F3	0.3500	0.3655	3F4	0.34920	0.35870
	0.3463	0.3687		0.3457	0.3621		0.3507	0.3724		0.34995	0.36553
	0.3507	0.3724		0.3500	0.3655		0.3551	0.3760		0.35420	0.36900
	0.3500	0.3655		0.3492	0.3587		0.3542	0.3690		0.35330	0.36200
	0.3457	0.3621		0.3451	0.3554		0.3500	0.3655		0.34920	0.35870
3G1	0.3446	0.3491	3G2	0.3440	0.3427	3G3	0.3485	0.3522	3G4	0.34775	0.34570
	0.3451	0.3554		0.3446	0.3491		0.3492	0.3587		0.34848	0.35220
	0.3492	0.3587		0.3485	0.3522		0.3533	0.3620		0.35240	0.35535
	0.3485	0.3522		0.3478	0.3457		0.3524	0.3554		0.35150	0.34870
	0.3446	0.3491		0.3440	0.3427		0.3485	0.3522		0.34775	0.34570

6. Characteristic Graphs

6-1 Voltage Characteristics(Ta=25°C)

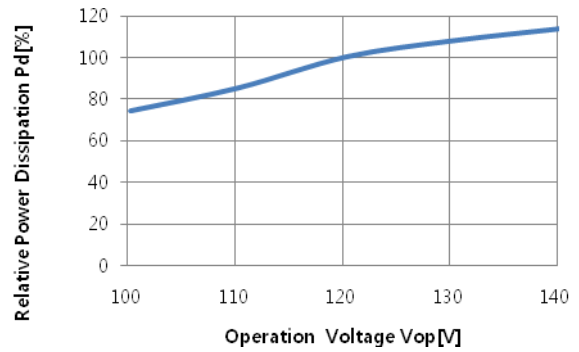
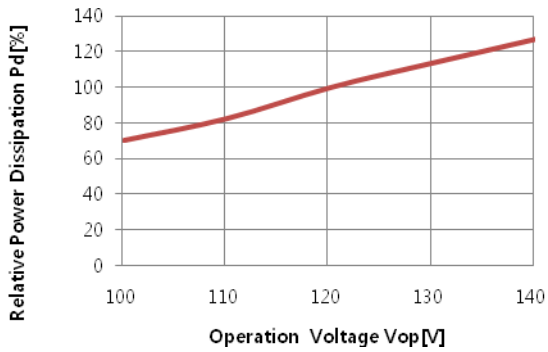

6-2 Spectrum Characteristics(Ta=25°C)

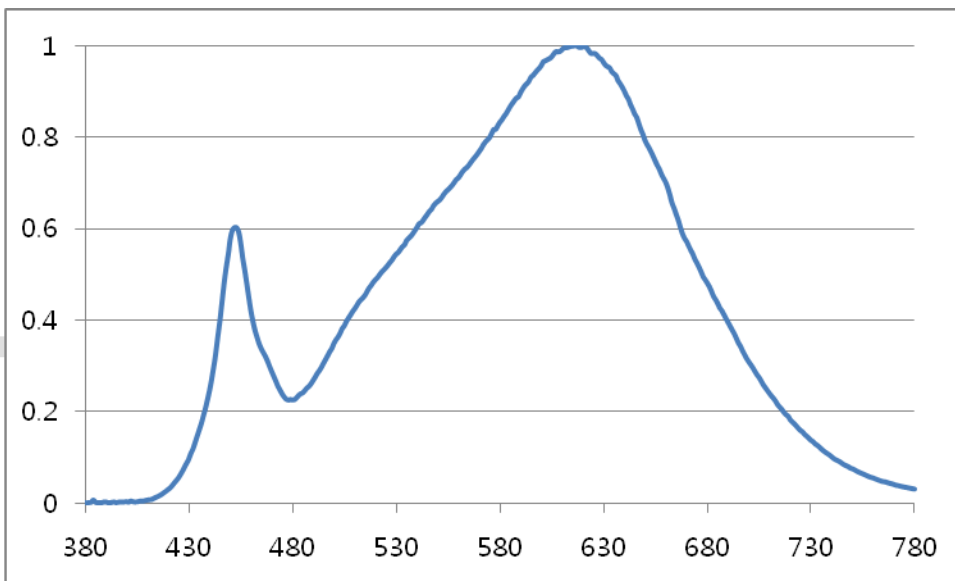

6-3 Temperature Characteristics

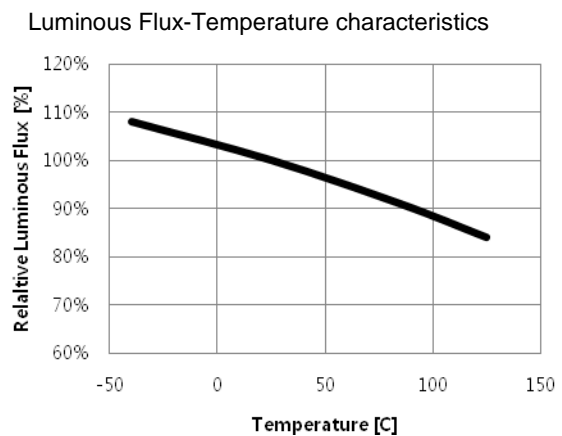
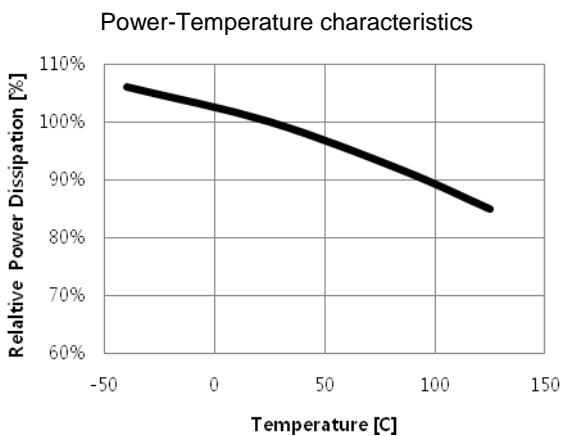

7. Outline Dimensions

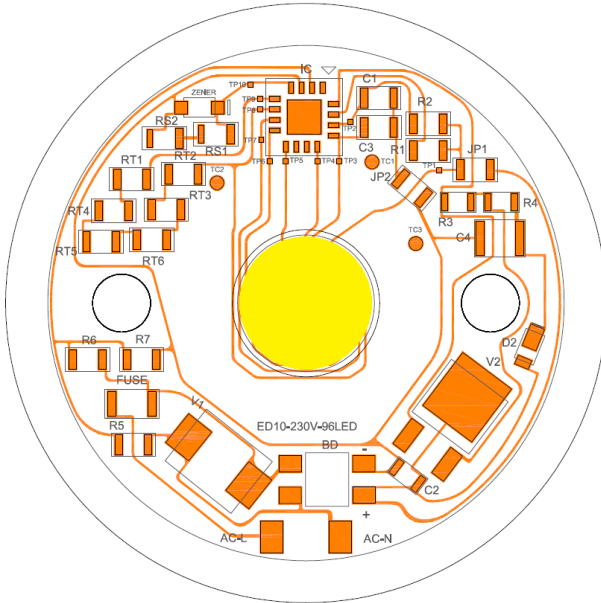

Unit : mm

- 1) Outline Diameter : 57 Φ Height(max) : 6.2mm
- 2) Tolerance - All measurements are ± 0.3 mm unless otherwise indicated.

8. Schematic (Module Circuit)

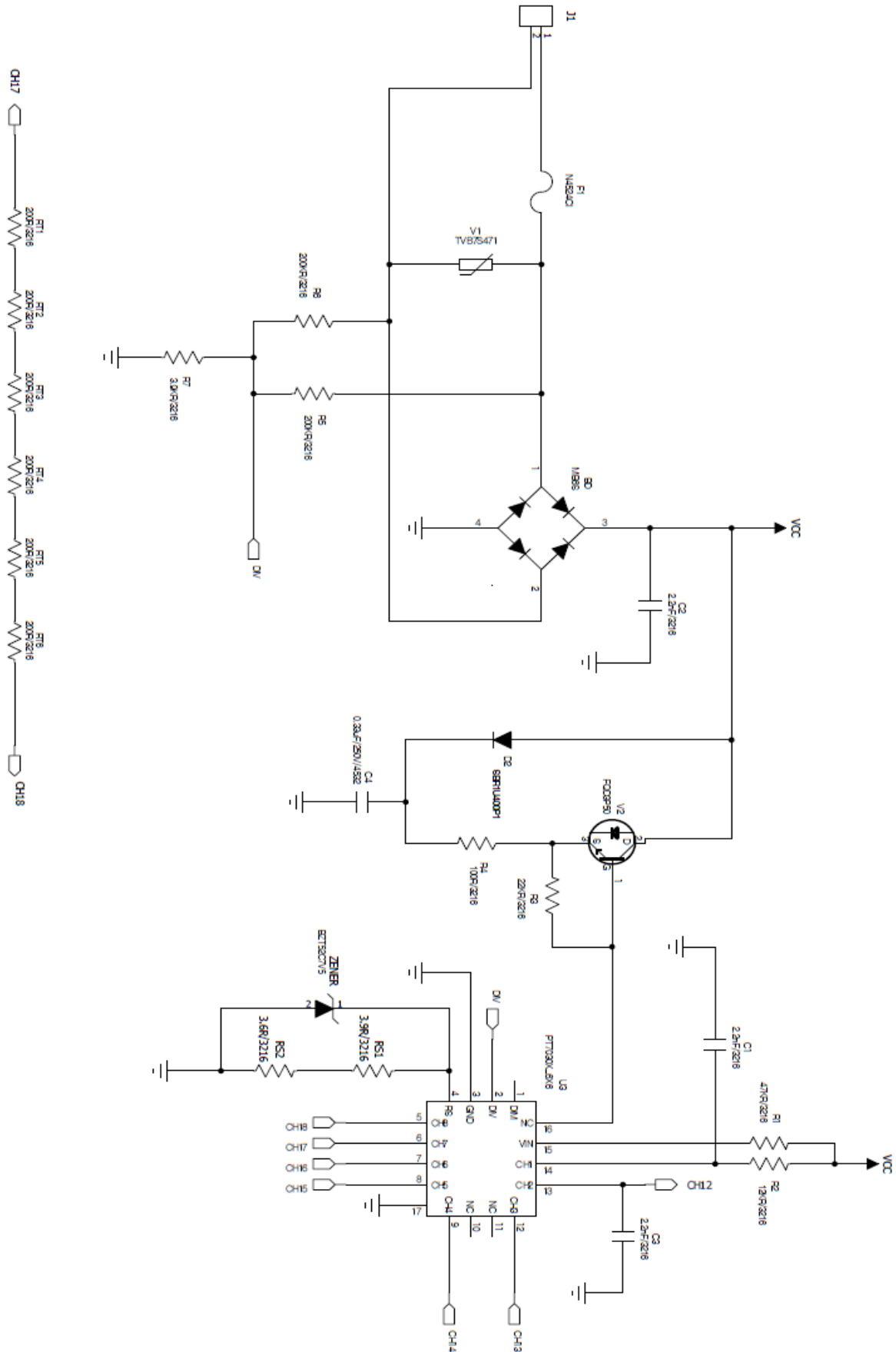

9. Part List

No.	Part	Location No.	Specification	Quantity
1	IC	IC	PT7030T 6x6	1
2	Zener Diode	ZENER	BZT52C7V5	1
3	Bridge Diode	BD	MB6S	1
4	Diode	D2	SBR1U400P1	1
5	Fuse	FUSE	N-4524CI125/2A 250V	1
6	Varistor	V1	TVB7S471	1
7	MOSFET	V2	FQD3P50	1
8	Capacitor	C1~3	3216 _ 2.2nF	3
9	Capacitor	C4	5750 _ 1.0uF	1
10	Resister	R1	3216 _ 47K Ohm	1
11	Resister	R2	3216 _ 12K Ohm	1
12	Resister	R3	3216 _ 22k Ohm	1
13	Resister	R4	3216 _ 100 Ohm	1
14	Resister	RS1	3216 _ 15 Ohm	1
15	Resister	RS2	3216 _ 13 Ohm	1
16	Resister	RT1~RT6	3216 _ 200 Ohm	6
17	Resister	R5~R6	3216 _ 200K Ohm	2
18	Resister	R7	3216 _ 2.7K Ohm	1
19	Resister	JP1~JP2	3216 _ 0 Ohm	2
20	Chip	Chip	3210 _CSP Blue Flip-chip	80
21	Phosphor	Green	GAL540	0.0174
22	Phosphor	Red	BR102Q	0.001566
23	Silicone	Si - A	Lumisil 868s - A	0.077517
24	Silicone	Si - B	Lumisil 868s - B	0.077517

10. Reliability test items and conditions

Item	Reference	Test Conditions	Duration / Cycle	Number of Damaged
Thermal Shock	EIAJ ED-4701	Ta =-40°C (30min) ~ 100°C (30min)	150 Cycle	0/4
Operating Endurance Test	Internal Reference	Ta =25°C, Vop = 120 V	1000 Hours	0/4
High Temperature High Humidity Life Test	Internal Reference	Ta =60°C, RH=90%, Vop = 120 V	500 Hours	0/4
High Temperature Life Test	Internal Reference	Ta = 60°C, Vop = 120 V	500 Hours	0/4
ESD		Air : 8kV Contact:4kV In the complete luminaire	20 Time	0/2

◆ CRITERIA FOR JUDGING THE DAMAGE

Item	Symbol	Criteria for Judgment		Condition
		MIN	MAX	
Power Dissipation	Pd	-	USL (1) × 1.1	Vop = 230 V
Luminous Flux	Φ_v	LSL (2) × 0.7	-	Vop = 230 V

(1) USL : Upper Standard Level

(2) LSL : Lower Standard Level

11. Cautions

- ◆ The LED Module itself and all its components may not be mechanically stressed.
- ◆ Make sure proper discharge prior to starting work.
- ◆ DO NOT touch any of the circuit board, components or terminals with body or metal while circuit is active.
- ◆ Installation of LED Module needs to be made with regard to all applicable electrical and safety standards. Only qualified personnel should be allowed to perform installation.
- ◆ DO NOT add or change wires while circuit is active.
- ◆ DO NOT make any modification on module.
- ◆ DO NOT use adhesives to attach the LED that outgas organic vapor.
- ◆ DO NOT use together with the materials containing Sulfur.
- ◆ The LED Module needs to be mounted on a heat sink providing adequate thermal dissipation.
- ◆ DO NOT exceed the values given in this specification
- ◆ Be cautious when soldering to board so as not to create a short between different trace patterns.
- ◆ Keep cautions not to apply higher voltage above the maximum rating. Otherwise damage may occur.
- ◆ Pay attention not to exceed the maximum operation temperature of 90 °C at the Tc Point when the modules are used in an enclosed environment.
- ◆ Maximum operating temperature for warranty coverage is 70 °C.
- ◆ DO NOT assemble in conditions of high moisture and/or oxidizing gas such as Cl, H₂S, NH₃, SO₂, NO_x, etc.
- ◆ The module should also not be installed in end equipment without ESD (Electrical Static Discharge) protection.
- ◆ Damage by corrosion will not be allowed as defect claim. Lumens LED Module is recommended for Indoor use only.
- ◆ Great care should be taken not to see directly the operated lighting LED. If not the intense light should cause the damage to eye. Use proper goggles to protect your eyes during operation.
- ◆ Long time exposure to sunlight or UV can cause the lens to discolor.
- ◆ Moisture-Proof package
 1. When moisture is absorbed into the LED light engine it may vaporize and expand products during manufacturing. There is a possibility that this may cause exfoliation of the contacts and damage to the optical characteristics of the LEDs. For this reason, the moisture-proof pack is used to keep moisture to a minimum in the package.
 2. A pack of a moisture-absorbent material (silica gel) is inserted into the shielding bag. The silica gel changes its color from blue to pink as it absorbs moisture.
- ◆ Storage Conditions
 1. Before opening the package: The LED light engines should be kept at 30 °C or less and 90% RH or less. The LED light engines should be used within a year. When storing the LED light engines, moisture-proof packaging with moisture-absorbent material (silica gel) is recommended.
 2. After opening the package: The LED light engines should be kept at 30 °C or less and 70% RH or less. The LEDs should be soldered within 168 hours (7 days) after opening the package. If unused LED light engines remain, they should be stored in moisture-proof packages, such as sealed containers with packages of moisture-absorbent material (silica gel). It is also recommended to return the LED light engines to the original moisture-proof bag and to reseal the moisture-proof bag again.
 3. Please avoid rapid transitions in ambient temperature, especially in high humidity environments where condensation can occur.

NOTE :

All the information published by Lumens is considered to be accurate and reliable. However Lumens does not warrant that product descriptions or other contents in this data sheet is accurate, complete, reliable, current, or error-free. Lumens disclaims any and all warranties and liabilities of an kind, including without limitation, warranties of non-infringement or implied warranty of merchantability of fitness for a particular purpose. The appearance and specifications of the product can be changed to improve quality, performance and/or design without advance notice. Lumens products are not authorized for use as critical components in life support devices or systems without the express written approval from the managing director of Lumens.